

"A" Series Variable Displacement Piston Pumps

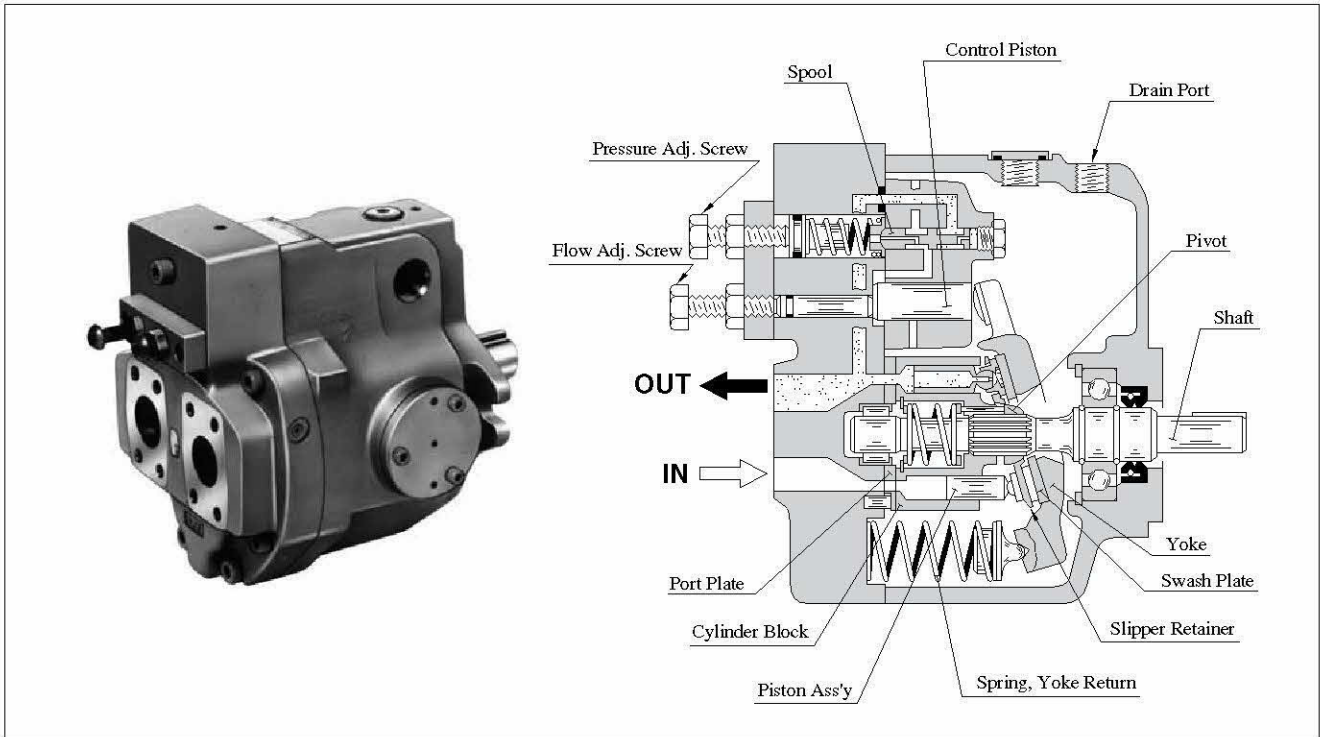

■ Features

● High efficiency

Under the conditions of pressure 16 MPa (2320 PSI) and speed 1800 r/min, the volumetric efficiency is over 98% and the overall efficiency is over 90%.

● Low noise level

In the "A16" pump, the noise level is as low as 57.3 dB(A) [at the full cut-off pressure 21 MPa (3050 PSI) with speed 1500 r/min one metre (3.3 ft.) horizontally away from pump head cover.]

"A16" type performance characteristics

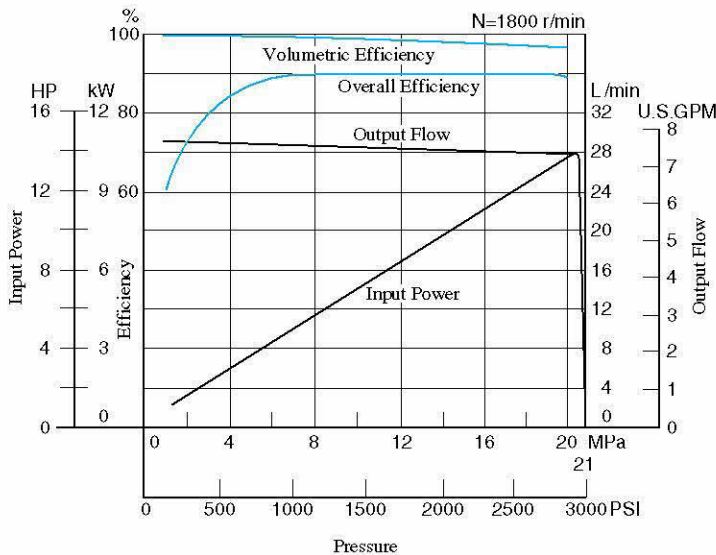

"A16" type noise level characteristics

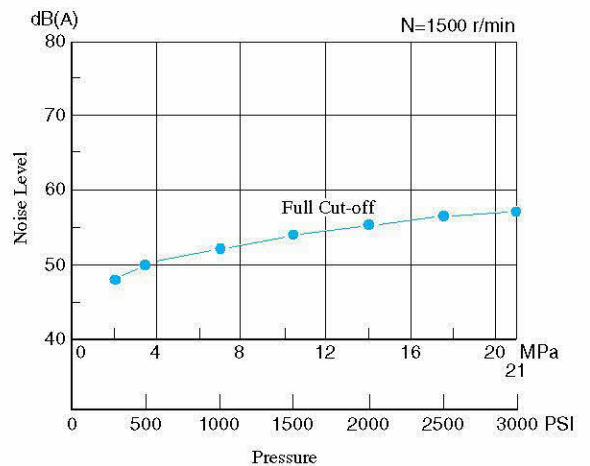

● Accomplishment of energy-saving

Because the overall efficiency is high and the cut-off characteristics is sharp, thus the input power may be saved.

● Low heat generation

Because of small power loss, it is possible to reduce the rise in oil temperature. Accordingly, capacity of a reservoir can be reduced.

Control Type

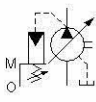
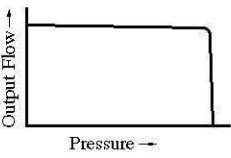
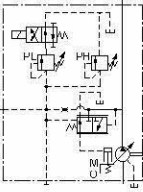
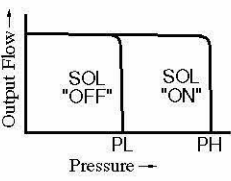
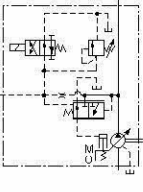
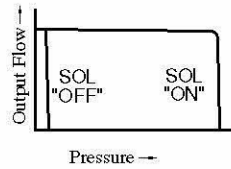
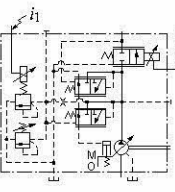
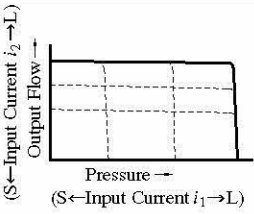
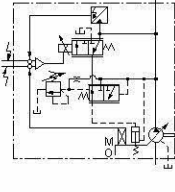
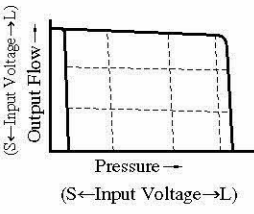
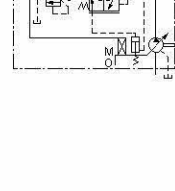
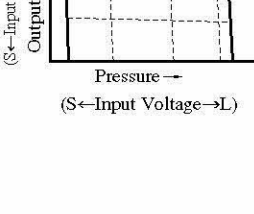
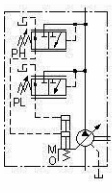
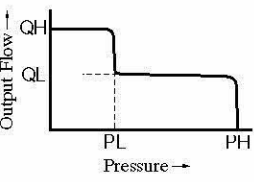
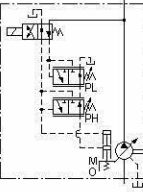
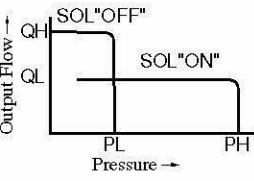
Control Type	Graphic Symbols	Performance Characteristics	Explanation	Page
"01" Pressure Compensator Type			When the system pressure increases and comes close to the preset cut-off pressure, the pump flow decreases automatically while maintaining the set pressure as it is.	33
"02" Solenoid-two Pressure Control Type			This type of control is ideal for an application where the output power of the actuator has to be controlled in two different load pressures while keeping the actuator speed nearly constant.	55
"03" Pressure Compensator with Unloading Type			It is suitable for a situation where a long unloading time is required and heat generation and noise have to be kept at their lowest levels. <ul style="list-style-type: none"> The pump can be used in combination with the multistage pressure control valve. 	63
"04" Proportional Electro-Hydraulic Load Sensing Type			This is an energy-saving type control which regulates the pump flow and load pressure to be at absolute minimum necessary level to operate the actuator. Pump flow rate and cut-off pressure are controlled proportional to the input current to the control device on the pump and the input current is regulated by the specific amplifier.	64
"04E" Electro-Hydraulic Proportional Pressure & Flow Control Type			This type of control has the pressure sensor and tilt angle sensor in the pump. The pump is used with the external amplifier (amplifier is integrated into pump in case of "04EH"). Flow and pressure can be controlled in proportion to input voltage by only one control valve.	74
"04EH" Electro-Hydraulic Proportional Pressure & Flow Control Type (OBE Type)			The features has been greatly improved by electrical feedback of swash plate tilt angle correspond to flow rate and load pressure to control valve. <ul style="list-style-type: none"> Linearity of input characteristics is excellent and easy to set. Hysteresis is lower, repeatability and reproducibility are fine. 	86
"05" Two-Pressure Two-Flow Control Type by System Pres.			This type of control is suitable for an application like "Presses" where the changeover from rapid advance to feed is required just when the pressing (pressurizing) starts.	—*
"06" Two-Pressure Two-Flow Control Type by Solenoid Valve			This pump control is suitable for machining found on machine tool, where machining starts after the changeover from rapid advance, to feed has been made.	—*

